

1. Publication Nº <i>INPE-2758-PRE/334</i>	2. Version	3. Date <i>May, 1983</i>	5. Distribution <input type="checkbox"/> Internal <input checked="" type="checkbox"/> External <input type="checkbox"/> Restricted
4. Origin <i>DMC/DEC</i>	Program <i>AERO</i>		
6. Key words - selected by the author(s) <i>SATELLITE FORCES</i> <i>SATELLITE AERODYNAMICS</i> <i>ATTITUDE CONTROLE</i>			
7. U.D.C.: <i>629.7.062.2:629.783</i>			
8. Title <i>THE MODELLING OF FORCES AND TORQUES ON NEAR EARTH SATELLITES - APPLICATION TO A PROPOSED BRAZILIAN SATELLITE</i>		10. Nº of pages: <i>12</i>	
		11. Last page: <i>11</i>	
9. Authorship <i>Nellore Srinivasan Venkataraman</i> <i>Valdemir Carrara</i>		12. Revised by <i>Santiago</i> <i>Santiago Alves Tavares</i>	
Responsible author <i>Venkataraman</i>		13. Authorized by <i>Parada</i> <i>Nelson de Jesus Parada</i> <i>Director</i>	
14. Abstract/Notes <i>The free molecular theory of rarefied gas dynamics and simple radiation theory are used to calculate the forces and torques on the proposed first Brazilian satellite. The direct solar radiation, albedo and earth emitted radiation are taken into account. The variation of these forces with the pertinent parameters as well as their orbital variations are discussed.</i>			
15. Remarks <i>This work will be presented at the VII Congresso Brasileiro de Engenharia Mecânica - COBEM 83 - Uberlândia, MG, December 13th to 16th, 1983.</i>			

ANAIS

PROCEEDINGS



COBEM 83

VII CONGRESSO BRASILEIRO DE
ENGENHARIA MECÂNICA

UBERLÂNDIA, 13 - 16 de dezembro de 1983



UFU

TRABALHO
PAPER

Nº

P.P.

THE MODELLING OF FORCES AND TORQUES ON NEAR EARTH SATELLITES
- APPLICATION TO A PROPOSED BRAZILIAN SATELLITE

NELLORE SRINIVASAN VENKATARAMAN
VALDEMIR CARRARA

Instituto de Pesquisas Espaciais - INPE
Conselho Nacional de Desenvolvimento Científico e Tecnológico - CNPq

SUMÁRIO

A teoria molecular dos gases rarefeitos e uma teoria simplificada da radiação eletromagnética foram usados para o cálculo das forças e torques atuantes no satélite proposto para a primeira missão espacial brasileira. A radiação solar direta, a radiação refletida pela Terra (albedo) e a radiação emitida pela Terra são consideradas neste trabalho. É discutida a influência de diversos parâmetros na força resultante, bem como sua variação ao longo de uma órbita característica.

SUMMARY

The free molecular theory of rarefied gas dynamics and simple radiation theory are used to calculate the forces and torques on the proposed first Brazilian satellite. The direct solar radiation, albedo and earth emitted radiation are taken into account. The variation of these forces with the pertinent parameters as well as their orbital variations are discussed.

1. Introduction

The extreme accuracy required in positioning and orienting satellites, as well as the study of their orbit decay and attitude, needs accurate modelling of the forces and torques on the satellites. Apart from gravity, the other forces acting on the satellite are aerodynamic, radiation and electromagnetic forces. The objective of this work is to briefly review the methods for calculating the aerodynamic and radiation forces acting on near earth satellites and apply them to the proposed Brazilian satellite. The aerodynamic force calculation is based mainly on the method of free molecular flow of rarefied gas dynamics, explained in detail by Schaaf and Chambré [1]. Application of this method to the European satellite TD1A has been done by Boettcher and Legge [2], while application to the SKYLAB has been done by Fredo and Kaplan [3]. The radiation forces which include direct solar radiation, the radiation reflected from earth (albedo) and the earth emitted radiation, is based on the formulation of Cunningham [4] and Georgevic [5]. For a detailed literature survey and description of the method, reference can be made to Carrara [6].

2. Aerodynamic Forces and Torques

The aerodynamic force is an important perturbative force at low altitudes. At the usual satellite altitudes the molecular mean free path is significantly larger than the characteristic dimension, so that the free molecular theory of rarefied gas dynamics has to be used for determining the surface forces. The major difficulty is to describe the gas-surface interaction, i.e., the specification of the gas property after reflection from the wall. Although a large amount of theoretical and experimental work has been done, the majority of the work is not directly applicable to practical situations and it is customary to use the tangential momentum accommodation coefficient σ and the normal momentum accommodation coefficient σ' which describe in a macroscopic scale the exchange of momentum between the gas and the surface [1], [2]. The two limiting cases are: a) specular

reflection with no accommodation, $\sigma = \sigma' = 0$, b) diffuse reflection with complete accommodation, $\sigma = \sigma' = 1$. σ and σ' depend on angle of incidence, surface temperature and finish etc. In view of the uncertainty in ascertaining their values σ and σ' are taken as given constants.

The normal pressure p and the shear stress τ on a surface element of area dA , is given by [1]

$$p = \frac{\rho U^2}{2 \sqrt{\pi} S^2} \left[e^{-S^2 \cos^2 \theta} \left\{ \frac{2 - \sigma'}{\sqrt{\pi}} S \cos \theta + \frac{\sigma'}{2} \sqrt{\frac{T_w}{T_i}} \right\} + \right. \\ \left. + \{1 + \operatorname{erf}(S \cos \theta)\} \left\{ (2 - \sigma') \left(S^2 \cos^2 \theta + \frac{1}{2} \right) + \frac{\sigma'}{2} \sqrt{\frac{T_w}{T_i}} S \cos \theta \right\} \right] \quad (1)$$

$$\tau = \frac{\rho U^2 \sigma \sin \theta}{2S \sqrt{\pi}} \left[e^{-S^2 \cos^2 \theta} + S \sqrt{\pi} \cos \theta \left\{ 1 + \operatorname{erf}(S \cos \theta) \right\} \right] \quad (2)$$

where

$$S = U \left(\frac{m_i}{2kT_i} \right)^{1/2} \quad (3)$$

where θ is the local angle of attack, the angle between the inward unit normal \hat{n} to the surface; and \vec{U} the velocity of the free stream relative to the surface ($\theta \leq \pi/2$); ρ is the ambient density. The shear stress τ is in the plane of \vec{U} and \hat{n} and along the unit tangent vector \hat{t} as shown in Fig. 1. T_i , T_w , k and m_i are the temperature of the incident gas, the wall temperature, the Boltzmann constant and the molecular mass, respectively. S is the speed ratio, which is the ratio of the satellite speed to the most probable molecular speed, and for typical satellite conditions varies from 3 to 10.

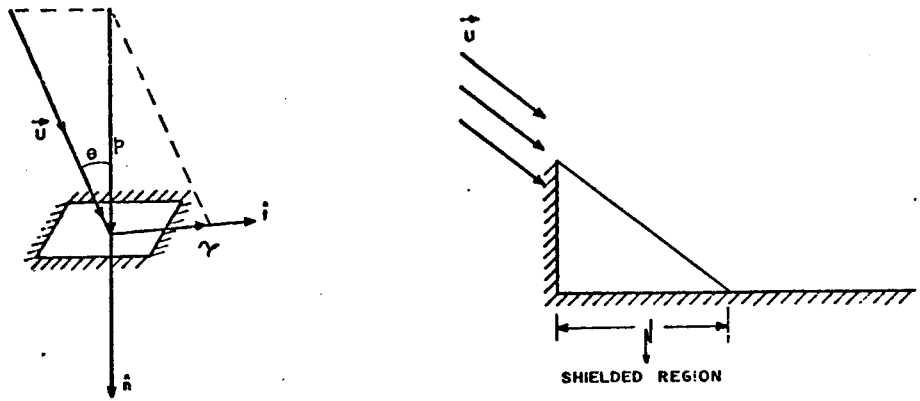

Fig. 1. The normal pressure and shear stress on dA and the shielded region.

Once the pressure and shear stress are known, the force \vec{F} and moment \vec{M} can be obtained by integrating these over the satellite area, and can be written symbolically as

$$\vec{F} = \int (p\hat{n} + \tau\hat{t})dA \quad ; \quad \vec{M} = \int \vec{r} \times (p\hat{n} + \tau\hat{t})dA \quad (4)$$

where \vec{r} is the position vector of the surface. The drag coefficient C_D based on a reference area A_{ref} is given by

$$C_D = 2\vec{F} \cdot \vec{U} / (\rho U^2 A_{ref}) \quad (5)$$

Similarly the force in any other direction can be nondimensionalized. It is important to note that equations (1) and (2) have been derived assuming that the surface is completely exposed to the free stream. In satellite applications, some of the surfaces may be shielded from the flow, for example, the solar panel or antennae of a satellite may shield the satellite body, depending on the flow orientation. While it is difficult to calculate the shielded areas exactly because the molecules will have some thermal velocity relative to the free stream, at high speed ratios the molecular motion can be assumed to be in the direction of free stream velocity \vec{U} . Thus, the surfaces in the shadow of other surfaces in the direction \vec{U} , as shown in the Fig. 1, are ignored. Another important aspect is that the

multiple reflections are neglected. This method has been applied to the proposed Brazilian satellite whose configuration is shown in Figure 2.

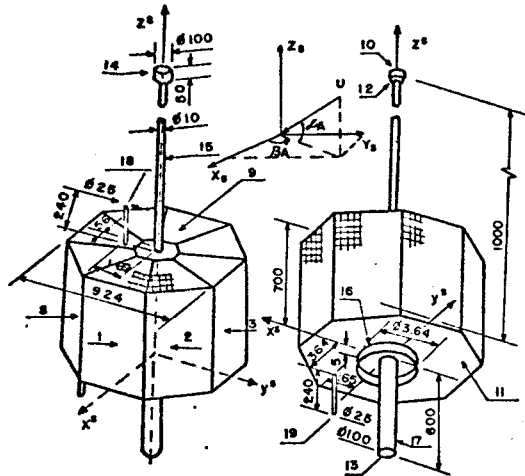
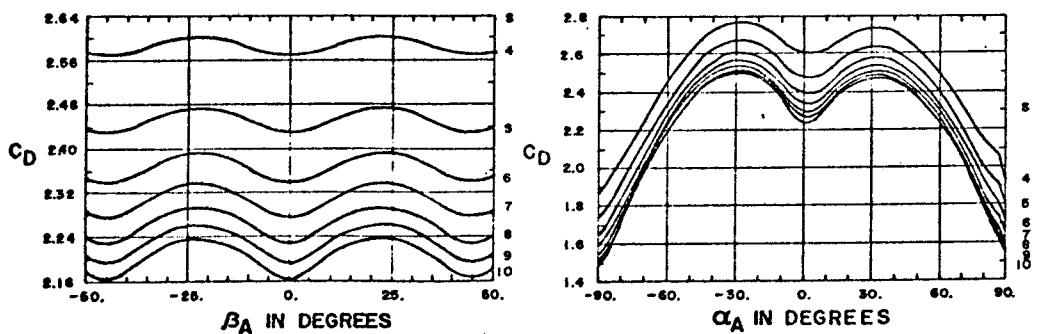

Fig. 2. The proposed Brazilian satellite.

For this satellite the shielding between the following parts in Figure 2 were considered, 9-15, 9-14, 9-18, 11-16, 11-17 and 11-19. Using the projected area of 1.067 m^2 as the reference area the aerodynamic forces and torques have been calculated for various values of pitch angle α_A , yaw angle β_A , S , σ , σ' and T_w/T_i . Some typical results for drag coefficient are presented in Figures 3 and 4.



Figs. 3. Variation of C_D with yaw angle, pitch angle and S .

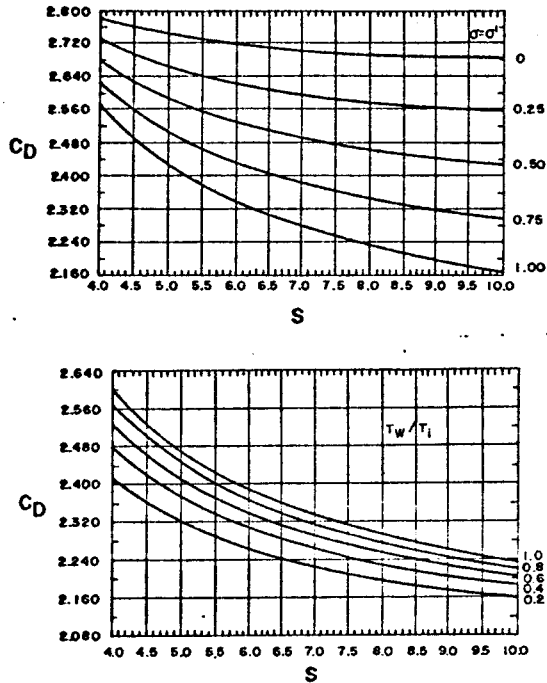

Fig. 4. Variation of C_D with S , σ , σ' and T_w/T_i .

3. Radiation Forces and Torques

The radiation forces acting on the satellite are due to direct solar radiation, albedo and earth emitted radiation. Because of space restrictions only a very brief description is given and details can be found in Carrara [6]. With diffuse reflection, diffuse emission and gray approximation, the expression for the normal pressure p_S and shear stress τ_S due to directly incident solar radiation is

$$p_S = \frac{S}{c} \cos \eta \left\{ (1 + \rho_S) \cos \eta + \frac{2}{3} (1 - \rho_S) \right\} \quad (6)$$

$$\tau_S = \frac{S}{c} (1 - \rho_S) \sin \eta \cos \eta \quad (7)$$

where S is the solar constant corresponding to satellite altitudes (≈ 1353 watts/m²); c is the velocity of light; η is the angle of incidence, i.e. the angle between the outward normal and the incident radiation, ($\eta \leq \pi/2$); ρ_S is the

specular reflection coefficient, i.e., the fraction of incident radiation reflected specularly. To obtain the forces and torques, these expressions have to be integrated over the satellite surface, taking into account only illuminated surfaces with the condition $\cos \eta \geq 0$.

The notation for calculation of albedo forces is shown in Figure 5. The axis z_a points towards the satellite and the sun is in the $y_a z_a$ plane.

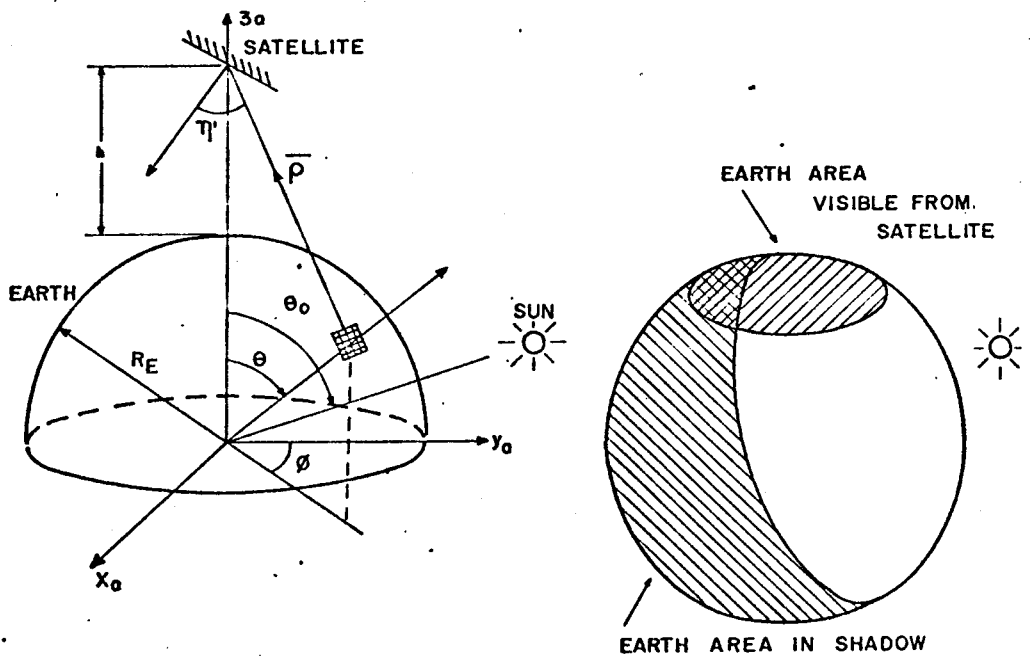

Fig. 5. Geometry for albedo force calculation.

The radiant energy flux d^2E_a reflected from a small area dA of earth and incident along $\vec{\rho}$, on a surface placed perpendicular to $\vec{\rho}$ per unit area per unit time, is [4]

$$d^2E_a = \frac{\alpha S (\sin \theta_0 \sin \theta \cos \phi + \cos \theta \cos \theta_0) (r \cos \theta - 1) dA}{R_E^2 \pi (1 + r^2 - 2r \cos \theta)^{3/2}} \quad (8)$$

where $r = (R_E + h)/R_E$ and α is the average albedo (0.34). To calculate the normal pressure p_a and the shear stress τ_a , due to albedo on a surface whose normal makes an angle η'

with $\vec{\rho}$, we can consider d^2E_a as the incident radiation and use equations (6) and (7) replacing S by d^2E_a . Thus, integrating over the surface of the earth, we get

$$p_a = \frac{\alpha S}{\pi c} \iint \cos \eta' \left\{ (1 + \rho_s) \cos \eta' + \frac{2}{3} (1 - \rho_s) \right\} \sin \theta \cdot \frac{(\sin \theta_0 \sin \theta \cos \phi + \cos \theta \cos \theta_0)(r \cos \theta - 1) d\theta d\phi}{(1 + r^2 - 2r \cos \theta)^{3/2}} \quad (9)$$

$$\tau_a = \frac{\alpha S}{\pi c} (1 - \rho_s) \iint (1 + r^2 - 2r \cos \theta)^{-3/2} \sin \eta' \cos \eta' \sin \theta \cdot (\sin \theta_0 \sin \theta \cos \phi + \cos \theta \cos \theta_0)(r \cos \theta - 1) d\theta d\phi \quad (10)$$

The limits of integration are established by the condition that only those areas of earth which are simultaneously visible from the satellite and illuminated by the sun have to be taken into account (Figure 5). This leads to the condition that $0 \leq \theta \leq \cos^{-1} 1/r$ and $-\phi_{\max} \leq \phi \leq \phi_{\max}$, where $\phi_{\max} = \pi$ if $\cot \theta \cot \theta_0 \geq 1$; $\phi_{\max} = \cos^{-1}(-\cot \theta \cot \theta_0)$ if $-1 \leq \cot \theta \cot \theta_0 \leq 1$ and $\phi_{\max} = 0$ if $\cot \theta \cot \theta_0 \leq -1$. In addition the condition $\cos \eta' \geq 0$ has to be satisfied and this may modify the limits on ϕ . The forces due to albedo are calculated by integrating p_a and τ_a over the satellite surface.

The solar radiation that is absorbed by the earth is distributed around the earth principally by conduction and convection. The temperature distribution can be calculated by making a balance between incident and absorbed radiation. In this analysis we assume that all the absorbed radiation is reemitted diffusely corresponding to the average temperature of the earth. The radiant energy d^2E_e emitted by a small area of earth and incident along $\vec{\rho}$ (Figure 5), on a surface placed perpendicular to $\vec{\rho}$ per unit area per unit time, is given by [6]

$$d^2E_e = \frac{(1 - \alpha) S (r \cos \theta - 1) \sin \theta d\theta d\phi}{4\pi(1 + r^2 - 2r \cos \theta)^{3/2}} \quad (11)$$

As before we can consider this as the incident radiation and calculate the normal pressure and shear stress due to earth

emitted radiation by a similar procedure using equations (6) and (7). The limits of integration will be $0 \leq \theta \leq \cos^{-1} 1/r$, $-\pi \leq \phi \leq \pi$ and $\cos \eta' \geq 0$. We can define nondimensional force coefficients as before, for example, the direct solar radiation coefficient C_{SR} can be defined as

$$C_{SR} = c \cdot \vec{F}_R \cdot \hat{S} / (S A_{ref}) \quad (12)$$

where \vec{F}_R is the force due to direct solar radiation and \hat{S} is the satellite Sun unit vector. The variation of this coefficient is shown in Figure 6, for various satellite orientations. For details of other coefficients reference can be made to [6].

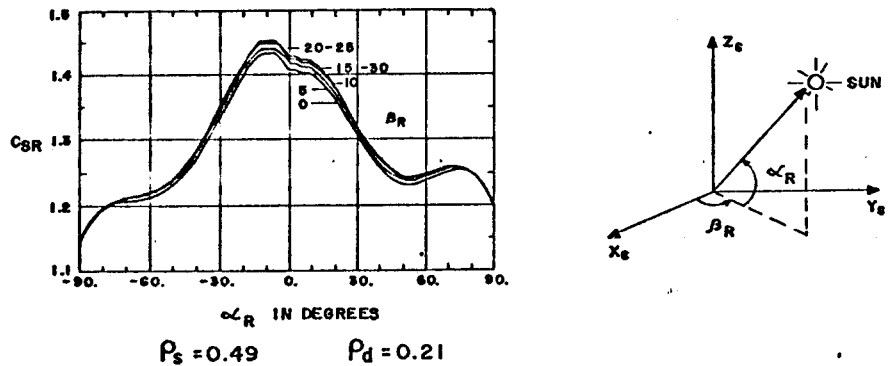

Fig. 6. The variation of the direct solar radiation coefficient.

4. Orbital Variation of the Forces

To have an idea of the relative magnitude of the forces, the aerodynamic and radiation forces were calculated for the proposed Brazilian satellite and some typical results are shown in Figures 7 and 8. The orbital velocity (not the relative velocity) is assumed to be along the x_s axis. The orbital parameters assumed are semi-major axis 7128 km, eccentricity 0.007 (corresponds to an altitude 750 km), inclination 22° , argument of perigee 14° . The sun position is defined by a right ascension of 256.25° and declination

of -22.84° , the date corresponding to December 10, 1983. With this configuration, the sun is practically in the orbital plane.

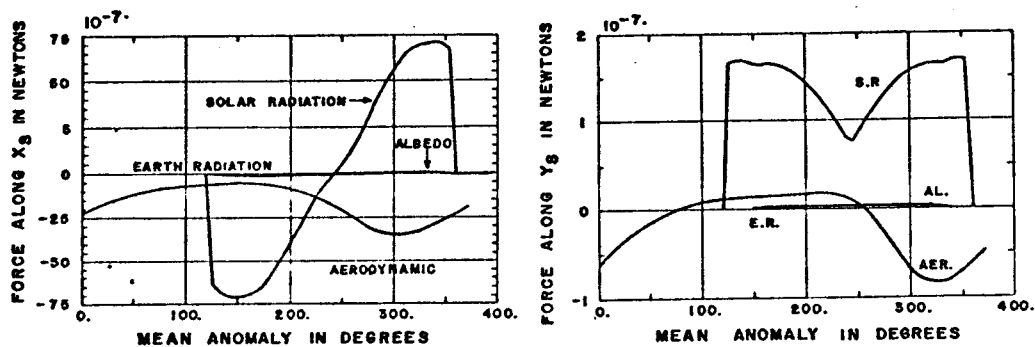

Fig. 7. Orbital variation of the force.

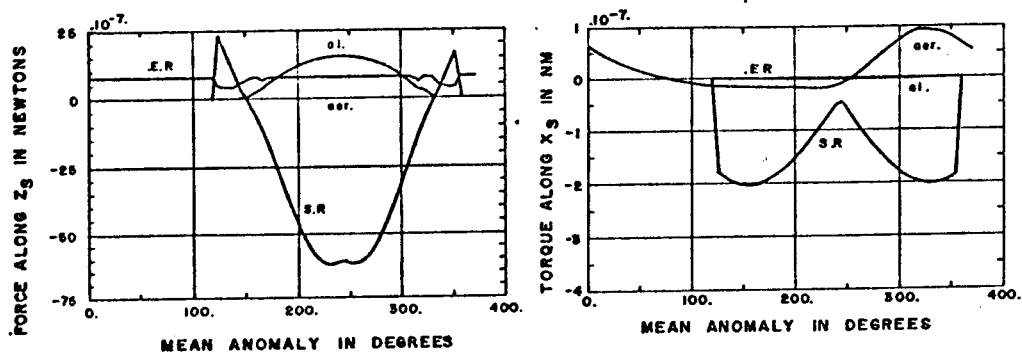

Fig. 8. Orbital variation of the forces and torques.

5. Discussions and Conclusions

The free molecular theory of rarefied gas dynamics and simple radiation with diffuse reflection and emittance have been used to calculate the forces and torques on the proposed Brazilian satellite. The experimental validation of the use of free molecular theory for satellites has been done by Boettcher and Legge [2]. An examination of Figures 3, 4, 6, 7 and 8 shows the following. The aerodynamic forces depend, in addition to geometry, on the parameters, σ , σ' , T_w/T_i . For

the proposed Brazilian satellite, at normal satellite speed ratios, a variation from completely specular to completely diffuse reflection changes drag by about 15% and this is an acceptable value considering the wide fluctuations in density that can occur in the atmosphere. The satellite wall temperature $T_w \ll T_i$ and the variation in C_D due to the variation of this parameter is small. The aerodynamic and solar radiation forces show a cyclic variation with a period of 45° as the satellite rotates about the z axis. The amplitude of this variation is about 5% for aerodynamic forces. The radiation forces are strongly dependant on satellite and orbital geometry. From Figure 7 it is seen that aerodynamic force is the principal cause of the decay and hence plays a very important role.

REFERENCES

- [1] Schaaf, S.A. and Chambré, P.L., "Flow of Rarefied Gases", Princeton University Press, Princeton, (1961).
- [2] Boettcher, R.D. and Legge, H., "Determination of Aerodynamic Forces on Satellites by Theory and Wind Tunnel Experiments", Acta Astronautica, vol. 7 (1980), pp. 255-267.
- [3] Fredo, R.M. and Kaplan, M.H., "Procedure for Obtaining Aerodynamic Properties of Spacecraft", Journal of Spacecraft and Rockets, vol. 18 (1981), pp. 367-373.
- [4] Cunningham, F.G., "Earth Reflected Solar Radiation Incident upon an Arbitrarily Oriented Spinning Flat Plate", NASA TN D-1842 (1963).
- [5] Georgevic, R.M., "The Solar Radiation Pressure Force and Torque Model", The Journal of the Astronautical Sciences, vol. 20 (1973), pp. 257-274.
- [6] Carrara, V., "Modelagem das Forças e Torques Atuantes em Satélites", M.Sc. thesis, Instituto de Pesquisas Espaciais, São José dos Campos, SP, Brazil, 1982.